

USER'S MANUAL

LABORATORY CENTRIFUGES CENTRIC CF 48 CENTRIC CF 48 R



<u>Edition</u>	<u>Month</u>	<u>Year</u>
9.	June	2023

ID 420397

DOMEL®

Domel, d.o.o.

Otoki 21, 4228 Železniki, Slovenia

Business Unit Laboratory Systems

Na Plavžu 79, 4228 Železniki, Slovenia

Tel.: +386 (0)4 5117 500

Internet: <https://www.domel.com>

CONTENTS

1. WARRANTY	4
2. GENERAL	4
2.1. Technical specifications	4
2.2. Dimensions / Positions of the feet	5
2.3. Accessory table	6
2.4. Packing list	6
2.5. Safety rules	7
2.6. Intended use	8
2.7. Practical notes on centrifugation	8
2.8. Actions forbidden during centrifugation	8
3. DESCRIPTION OF THE CENTRIFUGE	9
3.1. General view	9
3.2. Controls and Display	9
3.3. Safety devices	9
3.3.1. Device for closing and locking the lid	9
3.3.2. Manual unlocking of the lid	9
4. INSTALLATION AND SETTING UP	10
4.1. Unpacking the centrifuge	10
4.2. Load lifting	10
4.3. Installation	11
4.3.1. Environment	11
4.3.2. Power supply	11
4.3.3. Place of installation	12
4.4. Use	12
4.4.1. Switching on the centrifuge	12
4.4.2. Lid opening	12
4.4.3. Installing a rotor - SMART LOCK device	13
A. Rotor mounting	13
B. Rotor dismounting	13
4.4.4. Loading the rotor	13
4.4.5. Closing the lid	15
4.4.6. Automatic speed limitation	16
4.4.7. Detection of end of run - SMART LIGHT	16
4.4.8. Protocols at 4°C: Pre-Cool Function	16
5. CONTROL PANEL	17
6. PROGRAMMING	18
6.1. Parameter values	18
6.1.1. Speed (rpm) / Relative Centrifugal Force (RCF) / Radius	18
A. Centrifuge acceleration formula	18
B. Selection of Speed –Radius - Relative Centrifugal Force	18
C. Programming the speed (rpm) and centrifugal force (RCF)	18
6.1.2. Time	19
A. Programming the Time	19
B. Continuous centrifugation (Hold) mode	19
6.1.3. Acceleration and braking rates	19
6.1.4. Temperature	19
A. Pre-cooling	19
B. Programming Temperature	19
C. Instantaneous temperature reading	19

6.2.	Creating / Modification of a program.....	20
6.2.1.	Creating a program.....	20
6.2.2.	Locking a program.....	20
6.2.3.	Program selection	20
6.2.4.	Modification of a program	20
6.3.	Using a program.....	20
6.4.	Display functions during rotation.....	20
6.4.1.	Cycle parameter check.....	21
6.4.2.	RPM / RCF indication	21
6.4.3.	°C / °F temperature indication.....	21
6.5.	Force slope n°9 during braking.....	21
7.	EXTRA OPTIONS.....	22
7.1.	Language EN-FR	22
7.2.	Count AT-GO	22
7.3.	LBeep.....	22
7.4.	EBeep	22
7.5.	Speed RCF/RPM	22
7.6.	Greasing advice	23
7.7.	Refrigeration.....	23
7.8.	Pre-Diagnostic Mode.....	23
7.8.1.	Cool ON	23
7.8.2.	Power ON.....	23
7.8.3.	A loc.....	23
7.9.	Diagnostic mode	23
7.9.1.	Cod or 000	23
8.	CARE AND MAINTENANCE.....	24
8.1.	Daily care and cleaning	24
8.1.1.	External body	24
8.1.2.	Bowl and accessories.....	24
8.2.	Weekly care and cleaning	24
8.3.	Storage of accessories.....	24
8.4.	Action to be taken in the case of broken glass or accidental spillage.....	24
8.4.1.	Material presenting no toxic, biological or radioactive risk.....	24
8.4.2.	Material presenting a biological risk.....	25
8.4.3.	Material presenting a radioactive risk	25
8.4.4.	Material presenting a toxic risk	25
8.5.	Sterilization and disinfection of the rotor bowl and its accessories.....	25
8.6.	Checks and tests on accessories	25
8.7.	Yearly maintenance.....	25
9.	TROUBLESHOOTING / MESSAGES.....	26
10.	DISPOSAL	28
11.	CERTIFICATE OF DECONTAMINATION / RETURNS FORM	28
12.	LOGBOOK	31
13.	NOMOGRAM.....	32
14.	QUICK START	33
	EU DECLARATION OF CONFORMITY	34

1. WARRANTY

DOMEL centrifuges are guaranteed for two years by DOMEL d.o.o.

This warranty applies if:

- The centrifuge is used conforming to the instructions in the user manual.
- The electrical installation at the site of the centrifuge conforms to the IEC recommendations.

DOMEL declines all responsibility for damage caused by use not conforming to instructions, failure to carry out maintenance operations and any unauthorized modification.

Conforming to instructions for use comprises respecting instructions in the user manual and a carrying out of inspections and maintenance.



READ THIS USER MANUAL BEFORE THE FIRST OPERATION OF THE MACHINE

2. GENERAL

2.1. Technical specifications

CENTRIC CF 48 & CENTRIC CF 48 R models

Maximum capacity	4 x 400 ml swing-out rotor			
Maximum speed	4 500 rpm swing-out rotor			
Maximum RCF	3 830 x g swing-out rotor			
Temperature Display	-20 °C to 40 °C (refrigerated version)			
Timer range	0min 10s to 99h 59min and Hold			
External dimensions HxWxD				
CF 48 model	305 x 420 x 526 mm			
CF 48 R model	305 x 420 x 762 mm			
Power supply	230 V ± 10% 50/60 Hz 120 V ± 10% 50/60 Hz			
Model	CF 48		CF 48 R	
Version	230 V	120 V	230 V	120 V
Nominal Current	3.5 A	7 A	5 A	12 A
Maximum Power	840 W		1440 W	
Dissipated Heat	1194 BTU/hr		2729 BTU/hr	
Refrigerant / Charge			R449A	350 g
Maximum Noise	≤ 62 dB(A)		≤ 60 dB(A)	
Packaging HxWxD (recyclable packaging)	CF 48	460 x 610 x 650 mm		
	CF 48 R	460 x 610 x 890 mm		
Weight (net/gross)	CF 48	50 / 56 kg		
	CF 48 R	70 / 79 kg		

2.2. Dimensions / Positions of the feet

- Front View

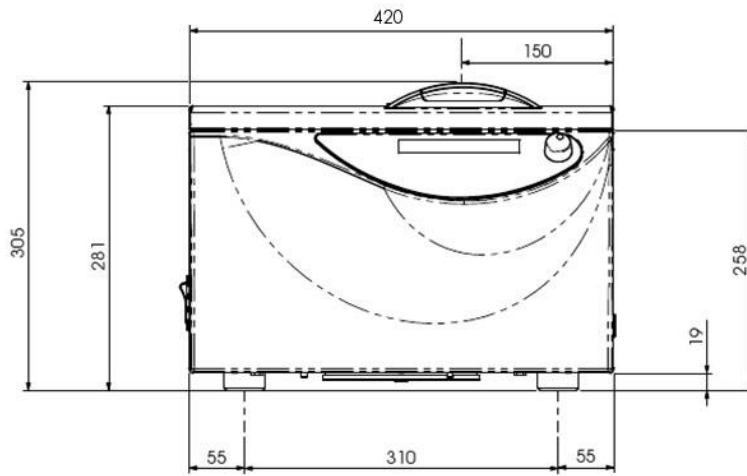

- Side View

Ventilated model

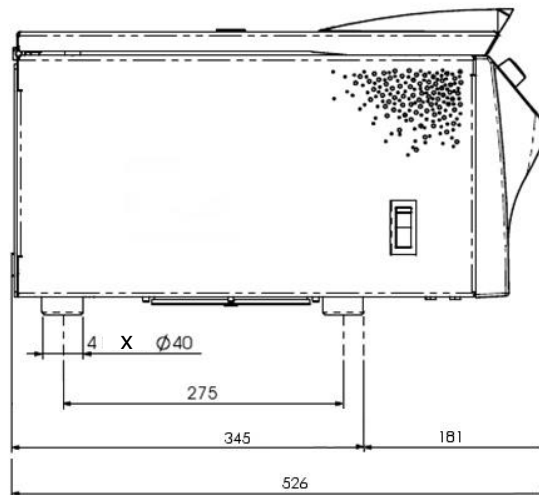

Refrigerated Model

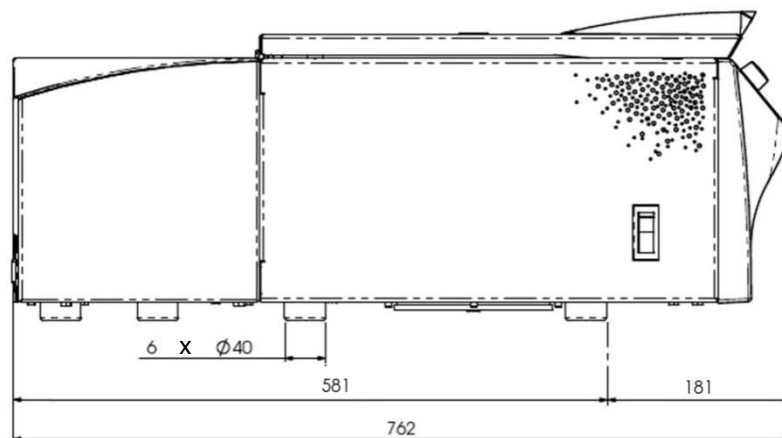

2.3. Accessory table

CENTRIC CF 48 & CENTRIC CF 48 R models

Description	Radius (mm)	Max. Speed (rpm)	RCF (x g)	Max. Vol. (ml)
RS 4/400 Swing-out rotor	169	4500	3830	4 x 400 ml
B 400 Set of 4 buckets				
BL 400 Set of 4 sealing lids				
I 400 13/2 Set of 4 inserts, capacity 13 x 1,5-2,0ml microtubes/insert	158	4500	3580	52 x 1,5-2,0 ml
I 400 14/5-7 Set of 4 inserts, capacity 14 x 5-7ml collection tubes/insert	161	4500	3640	56 x 5-7 ml
I 400 15/5-7 Set of 4 inserts, capacity 15 x 5-7ml BD branded collection tubes/insert	161	4500	3640	60 x 5-7 ml
I 400 19/5-7 Set of 4 inserts, capacity 19 x 5-7ml Terumo branded collection tubes/insert	162	4500	3670	76 x 5-7 ml
I 400 12/10 Set of 4 inserts, capacity 12 x 10ml collection tubes/insert	161	4500	3640	48 x 10 ml
I 400 7/15 Set of 4 inserts, capacity 7 x 15ml conical bottom tubes/insert	166	4500	3760	28 x 15 ml
I 400 5/20 Set of 4 inserts, capacity 5 x 20ml round bottom tubes/insert	168	4500	3800	20 x 20 ml
I 400 3/50 Set of 4 inserts, capacity 3 x 50ml conical bottom tubes/insert	168	4500	3800	12 x 50 ml
I 400 4/50 Set of 4 inserts, capacity 4 x 50ml conical bottom tubes/insert	168	4500	3800	16 x 50 ml
I 400 1/100 Set of 4 inserts, capacity 1 x 100ml round bottom 52mm diameter tubes/insert	166	4500	3760	4 x 100 ml
I 400 1/150 Set of 4 inserts, capacity 1 x 150ml CORNING branded conical bottom tubes/insert	166	4500	3760	4 x 150 ml
I 400 1/250 Set of 4 inserts, capacity 1 x 250ml flat bottom tubes/insert	166	4500	3760	4 x 250 ml
RM 2/6 Microplate rotor	127	4100	2390	6 plates or 2 deepwell plates
Set of 2 buckets capacity 2x3 microplates, 2x1 deepwell plates for RM 2/6				

2.4. Packing list

- Centrifuge CF model
- Power cord (mains cable)
- User manual
- Allen wrench for manual unlocking of the cover
- Tube of food quality grease

2.5. Safety rules

The operator must respect the following precautions:

- Do not attempt to open the cover while the display indicates that the end of the centrifugation run has not been reached.
- Do not attempt to override the lid locking system during operation of the centrifuge.
(See chapter 3.3.2 *Manual unlocking of the lid*).
- Use only an electrical socket with a ground (an earth) connection that corresponds to the indications on the manufacturer's plate on the centrifuge.
- Install the centrifuge in a well ventilated space on a rigid, horizontal support that can absorb vibration generated by the centrifuge.
- Do not lean over the centrifuge during a centrifugation run.
- Do not remain within the clearance envelope (30 cm around the centrifuge) longer than necessary for service reasons.
- Do not place potentially dangerous material within the operating space.
- Use accessories sealed against aerosols when centrifuging and material that presents a biological risk.
- Check the mounting and balancing of the rotor before starting this centrifugation run.
- Take care to maintain and check the accessories. (See chapter 8. *Care and maintenance*).
- Keep the centrifugation chamber clean and dry.
- Check that bottles and tubes can withstand centrifugation, chemical resistance to the products centrifuged and mechanical resistance to the centrifugal force applied to them.
- When moving the centrifuge from a cold environment to a warmer environment, condensation can form inside the centrifuge. Leave the centrifuge to warm up for three hours before use.
- If the centrifuge is used in a manner not specified in the present manual, the protection provided by the equipment may be impaired.
- Centrifuges are designed for interior use by personnel trained to use them.

2.6. Intended use

Centrifuges CENTRIC CF 48 and CENTRIC CF 48 R are laboratory centrifuges intended to be used in laboratories for separating the substances with different specific densities by centrifugal force.

2.7. Practical notes on centrifugation

- Check that the centrifuge is stable and horizontal.
- Check that the rotor is correctly fitted before starting a centrifugation run.
- Check that tubes can resist the maximum centrifugal force applied (See *chapter 2.3 Accessory table*).
- Check that tubes are in good condition -- eliminate damaged tubes.
- During operation, the centrifuge must not be moved or knocked.
- Use only the rotors and accessories authorized by the manufacturer (See *chapter 2.3 Accessory table*).
- Balance the rotor.
- For swing out rotors, always puts all the buckets and inserts (even empty) in their dedicated location.
- **Respect the maximum density of 1.2 g/ml, particularly when using maximum speed.**
- Limit the volume if the density is exceeded.

2.8. Actions forbidden during centrifugation

It is forbidden to centrifuge the following material:

- Inflammable or explosive material.
- Material that could react chemically with sufficient force to create danger.

The centrifuge is not designed to operate in an explosive environment.

It is forbidden to centrifuge toxic or radioactive material or material contaminated by pathogenic microorganisms in containers that are not sealed against aerosols and, if necessary, radiation.

It is forbidden to use rotors and accessories having exceeded the maximum usable lifetime of 10 years, or 35000 runs ⁽¹⁾ in normal use condition & maintenance, or showing signs of wear, traces of corrosion or mechanical faults.

A warning message is displayed on the centrifuge after 30000 cycles, it is then necessary to call DOMEL service to inspect the accessory and erase this warning.

⁽¹⁾ On 1st of 2 terms expired.

3. DESCRIPTION OF THE CENTRIFUGE

3.1. General view

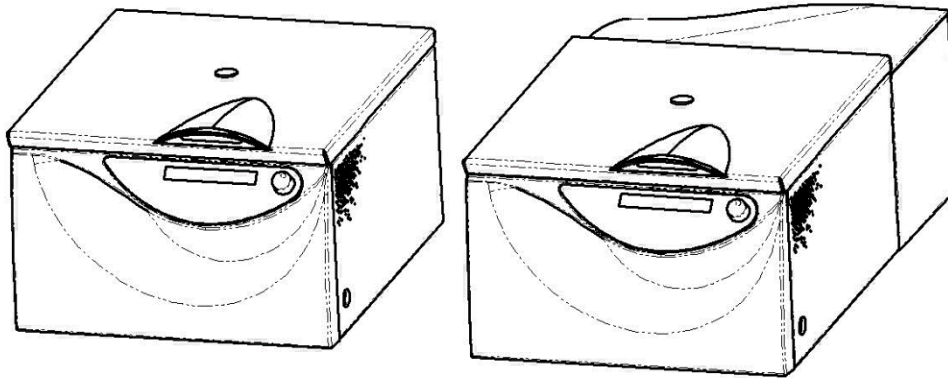

Ventilated model

Refrigerated model

3.2. Controls and Display



Refrigerated models

3.3. Safety devices

3.3.1. Device for closing and locking the lid

CF series centrifuges are fitted with a device for locking the lid to ensure the safety of the operator. The centrifugation run can only start once the lid is correctly shut and locked. During the run it is impossible to open the lid. This is only unlocked once the rotating accessories (rotor) have come to a complete stop.

3.3.2. Manual unlocking of the lid



Only in case of electrical problem

Manual unlocking of the lid must be carried out by a person trained in the use of the centrifuge and understanding the mechanical risks:

- Risks of wounding if the operator attempts to brake the rotor manually during rotation.
- Risk of the projection of aerosols in the case of broken tubes within the centrifugation chamber.

In the case of a power outage (power cut), wait 15 minutes before attempting to unlock the lid manually: the rotating rotor will decelerate without braking.

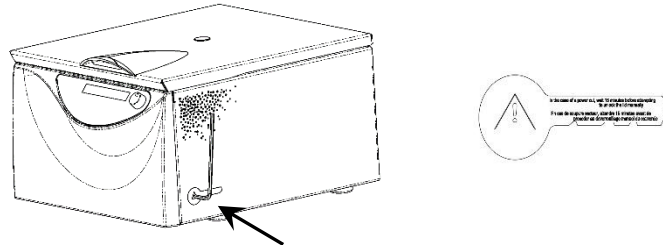

Equipment: Allen wrench provided.

- Put the main switch in position O.
- Insert the unlocking device in the hole situated on the lower right side of the centrifuge punching the sticker.
- Connect the wrench and turn it clockwise: the closing mechanism will unlock the lid that will lift slightly.
- Lift the lid manually.

After a manual unlocking, the message "Press Lid Button" is displayed. Press the  key to reinitialize the locking device.



Contact a DOMEL certified technician to get the locking device checked, and the replacement of the sticker.

4. INSTALLATION AND SETTING UP

Transporting the equipment over a long distance must be done by mechanized means, handled by personnel trained in its use.

4.1. Unpacking the centrifuge

Remove the centrifuge from its packaging by lifting it, holding the lower part.

Beware: refrigerated models require two persons for this operation.

Remove the other items from the packaging: power cable, manual, tools. Check that nothing remains in the packaging before disposing of it. The packaging is made of card that can be recycled and should be treated in the appropriate way.

4.2. Load lifting

2 people are necessary to lift and manipulate the centrifuge.

WARNING: Manipulate the centrifuge handling underneath, and not the front panel.

4.3. Installation

4.3.1. Environment

Avoid corrosive, high humidity atmosphere.

Avoid direct sunlight that could result in heating of the instrument.



The centrifuge is not designed to operate in an explosive environment.

Environmental conditions:

- To be used inside.
- Standard operating temperature: 25 °C.
- Maximum relative humidity of 80% for temperatures up to 22 °C.
- Maximum altitude: 2000 m.

Maximum performance is assured within the temperature range from 15 °C to 25 °C.

Electrical environment:

Installation category: 2

Pollution degree: 2

EMC Performance:

Conforms to EN61326-1 concerning Emissions and Immunity.

4.3.2. Power supply

Check that the electrical supply corresponds to the indications on the manufacturer's plate.

Power supply to the instrument must be provided by a socket with a ground (an earth) connection and a protective device ensuring that the power is automatically cut in case of a fault in the insulation.

A supply fitted with a differential circuit breaker of a suitable rating satisfies this requirement.

To allow electrical isolation of the device, the socket must be readily identifiable and within easy reach of the operator.

The electrical installation must include an emergency stop switch enabling the supply to be cut in the case of irregular operation. This switch must be placed at a distance from the centrifuge (outside the limits of the centrifuge operating space) and preferably outside of the room in which the centrifuge is placed.

4.3.3. Place of installation

Place the centrifuge on its support or on a flat, horizontal bench that is fixed and can support its weight (See chapter 2.1 *Technical specifications*).

Take care to mark out an operating space, 30 cm all around the instrument.

Do not block the ventilation slots on the sides of the instrument, towards the front.

Mount a rotor in the centrifuge (See chapter 4.4.3 *Installing a rotor - SMART LOCK device*). Place a spirit level on the rotor and check the flatness in two directions at 90° to each other.

Adjust the support or bench if necessary.

If vibrations occur within a certain speed range during start-up, this is because of resonance. Check the base and make sure that the table or support under the centrifuge is sufficiently stable and that all four legs are firmly on the ground.

4.4. Use



4.4.1. Switching on the centrifuge

The switch/circuit breaker for switching on the centrifuge is found on the front left-hand side of the instrument.

4.4.2. Lid opening

The centrifuge that you have purchased is equipped with a motorized lid lock. Manually lift the lid to open completely. For the first start, the centrifuge is delivered with its lid opened. It may be that after a prolonged storage of the machine, the gas springs have a longer response time. The first opening may be less straightforward. In this case, do some manual movements with the lid in order to properly activate the opening mechanism.

If the lid is closed, press the lid button  and support the lid with the left hand if necessary.

4.4.3. Installing a rotor - SMART LOCK device

The CF series centrifuges are designed with the **SMART LOCK** device. The rotor can be exchanged without tools.

A. Rotor mounting

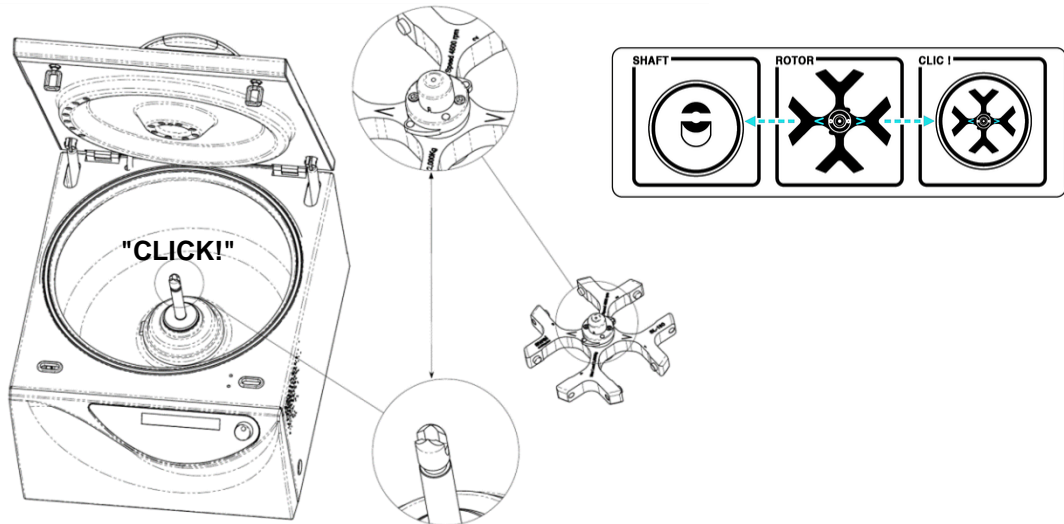

Position the rotor over the drive shaft ensuring that the reference mark in the centre of the rotor lines up with that on the drive shaft. Press down on the rotor. A 'click' signals the locking of the rotor. Attempt to lift the rotor. If this operation is impossible, the rotor is correctly locked. If the contrary, reposition the rotor and proceed as indicated above.

B. Rotor dismounting

Squeeze the two levers in the central part of the rotor. The rotor can be lifted slowly. Remove it from the centrifugation chamber.

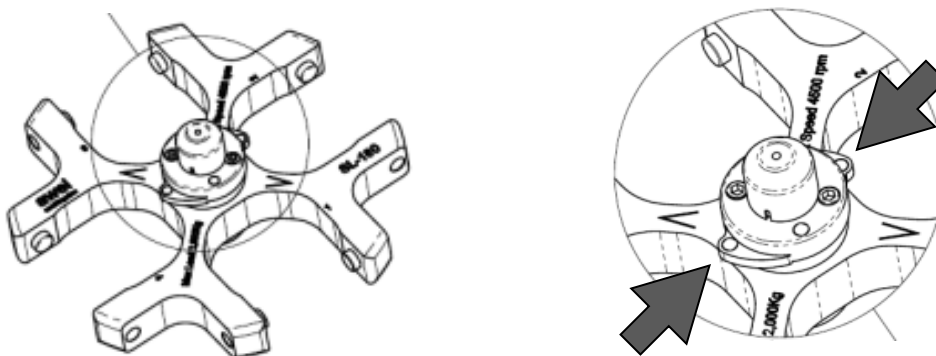

4.4.4. Loading the rotor



For swing out rotors, always put all the buckets and inserts (even empty) in their dedicated location.

Rotors must be balanced for load about a symmetrical axis: the contents of each pocket in the rotor or insert must be balanced in weight with that of the diametrically opposite position.

The tubes or bottles must be balanced by pairs that are placed opposite each other. In the case of an odd number of tubes, balance the last one by adding a tube, filled with water, of the same total weight.

Bucket static balancing:

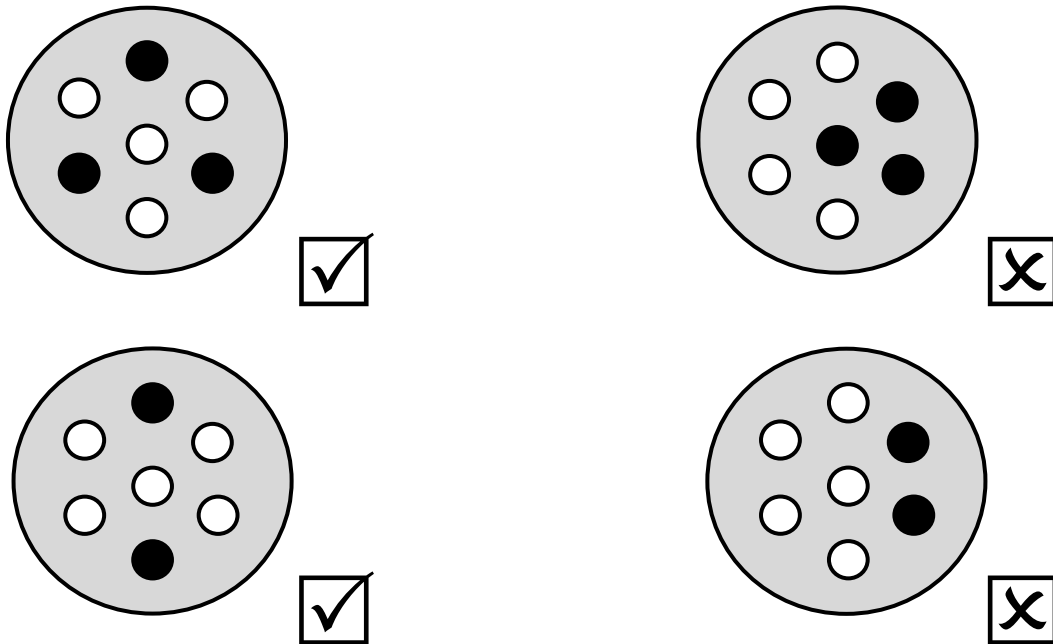

Angular rotor dynamic balancing:

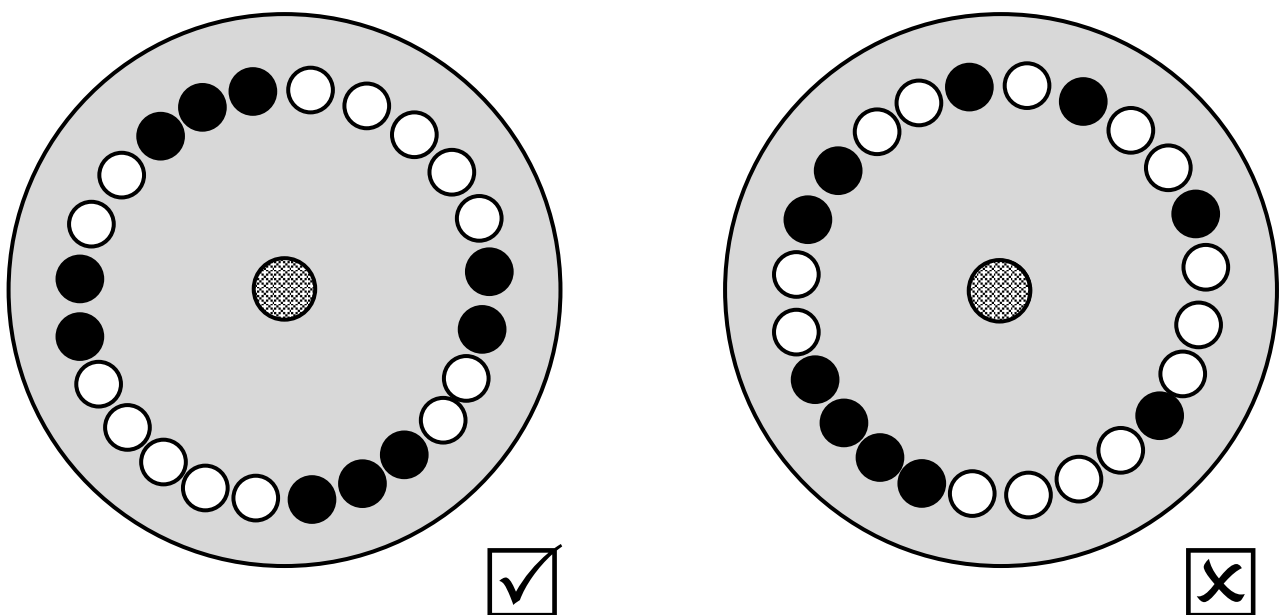

Swing-out rotor dynamic balancing:

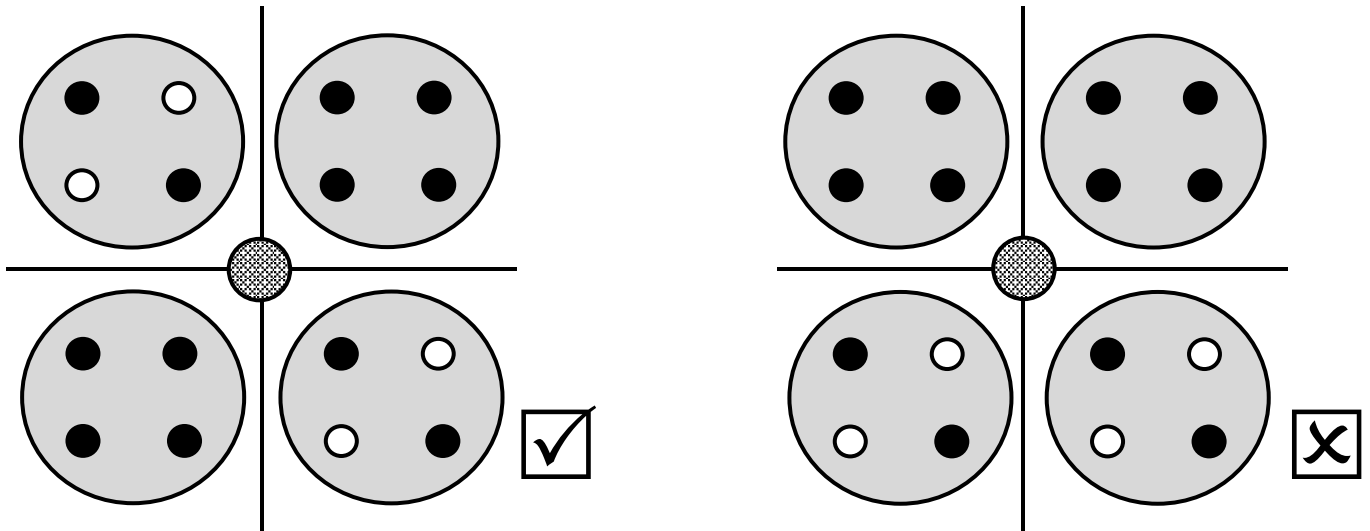

The centrifuge can tolerate an imbalance of 10 g.

Important Note: The imbalance detection system automatically shuts down the centrifuge in case of excessive imbalance (> 25 g) and displays the error code Err01. Moderate imbalance (10 to 25 g) generates vibrations that can cause or stop by detecting imbalance (Err01) or a cap at low speed.



An excessive imbalance is likely to seriously damage the rotor and the centrifuge.

4.4.5. Closing the lid

Once the rotor has been loaded, to close the lid, put your hand on the handle, and lower the lid. Keep pressing the lid during the blinking of the handle. A buzzer sounds for the interlock. You can release the lid which is now locked.



Warning: Place the hand flat on the top of the lid while pushing it.



When closing the lid, make sure you place all the fingers on the top of the lid.



ATTENTION! When closing the lid, do not put fingers between the lid and the centrifuge frame, because the motorised lid will pinch your fingers!





4.4.6. Automatic speed limitation

If the set speed is too high corresponding to the installed rotor, the spinning speed is automatically limited.

In this case, the spinning flash turns differently, and 3 "beep" sounds are regularly emitted. The speed setting is adjusted to the maximum allowed for the rotor installed.

4.4.7. Detection of end of run - SMART LIGHT

To visually identify the end of a cycle, the light in the handle flashes.

The  and  keys also flash, indicating the possibility to open the lid, or to start a new cycle.



SMART LIGHT Device

4.4.8. Protocols at 4°C: Pre-Cool Function

To obtain optimal performances at 4°C, the "Pre-Cool" key  permits to prepare the centrifuge before use. This pre-set cycle of pre-cooling must be completely carried out, to lower the bowl temperature as well as rotor & spinning accessories temperature.

Samples to separate must be stored at required temperature (i.e. 4°C) before placed in the centrifuge.

5. CONTROL PANEL

Display:

- ① Program Number
- ② Speed / RCF (Relative Centrifugal Force) / Radius
- ③ Time
- ④ Temperature (Refrigerated models) / Acceleration and Braking Rates

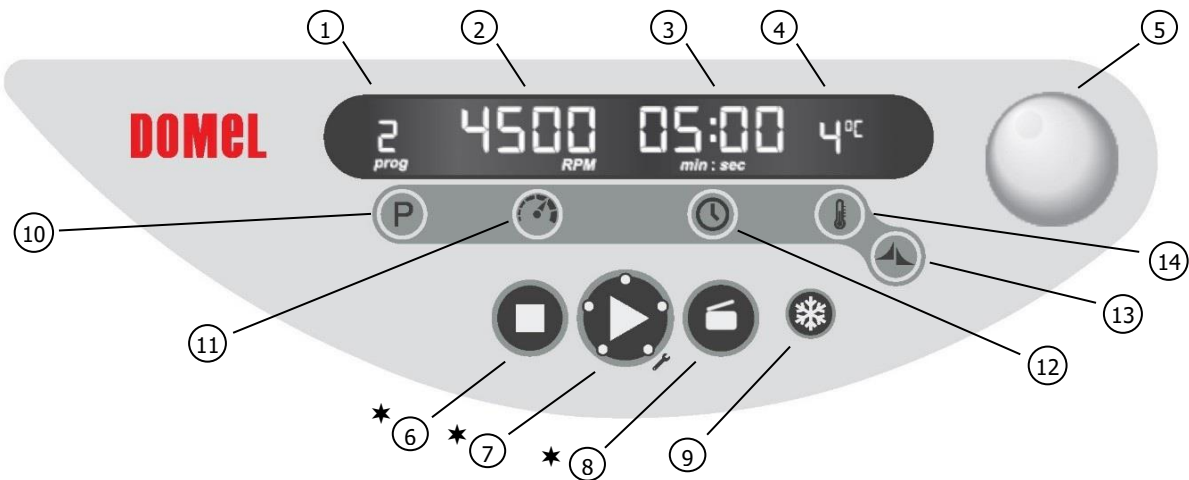

Control keys:

- ⑤ Adjustment knob
- ⑥ Stop and Escape
- ⑦ Start
- ⑧ Open Lid / Lock Program
- ⑨ Pre-Cool (Refrigerated models)
- ⑩ Access to the program number
- ⑪ Access to the speed / RCF
- ⑫ Access to the duration of the cycle
- ⑬ Access to the acceleration / braking slopes
- ⑭ Access to the temperature control (Refrigerated models)

* Intuitive keys:
For easier use of the control keys:
keys ⑥, ⑦ and ⑧ brighten when the
control is possible.

6. PROGRAMMING

6.1. Parameter values

Parameter values are entered directly with the help of the specific key and the value adjustment knob.

6.1.1. Speed (rpm) / Relative Centrifugal Force (RCF) / Radius

A. Centrifuge acceleration formula

$$RCF_{(g)} = \frac{\pi^2 N^2 r}{9.10^5 g}$$

N: Rotation speed, in rotation / minute (rpm)

r: Radius, in mm

g: 9.81 m.s⁻²

F: Centrifuge acceleration, or g number

Approximation:

$$F = 1.118 \times r \times \left(\frac{N}{1000} \right)^2$$

To calculate Speed from Relative Centrifugal Force:

$$N = 1000 \times \sqrt{\frac{F}{1.118 \times r}}$$

B. Selection of Speed –Radius - Relative Centrifugal Force

Repeated pressing on the  key enables the speed, centrifugation radius and relative centrifugal force to be displayed successively.

The centrifuge can be configured to display by default speed or centrifugal force.

A long press on the  key allows checking the current set point in the alternate unit.

Once the key released, the default unit is used again.

C. Programming the speed (rpm) and centrifugal force (RCF)

Select the speed (rpm) or relative centrifugal force (RCF) using the  key.

Press the key firmly until the display goes to programming mode: only the rpm value appears in a grey colour. Repeated pressing on the key enables the speed, centrifugation radius and relative centrifugal force to be displayed successively.

Select the required value with the help of the knob while in programming mode. The new value is automatically saved after 5 seconds or if the key for another parameter is pressed.

Do not forget to set the radius value (RAD) of the mounted rotor, to obtain the speed (RPM) or the centrifuge acceleration (RCF) required.

Refer to the accessories table to determine the maximum speed.

If the set speed is too high corresponding to the installed rotor, the spinning speed is automatically limited.

In this case, the spinning flash turns differently, and 3 "beep" sounds are regularly emitted: The speed setting is adjusted to the maximum allowed for the rotor installed.

6.1.2. Time

A. Programming the Time



Press the Time key  firmly until the display of the time goes to programming mode: only the time value appears in a grey colour. Select the required time value with the help of the knob while in programming mode.

Selectable range: From 0min10s in steps of 10 seconds then from 1h00min to 99h59min in steps of 1 minute.

The new value is automatically saved after 5 seconds or if the key for another parameter is pressed.

B. Continuous centrifugation (Hold) mode

Select the value "--:--" .

Start the run by pressing the Start button  . The centrifuge runs until the Stop button  is pressed.

6.1.3. Acceleration and braking rates

Press the  key: only the acceleration rate is displayed in grey. Select the required acceleration rate with the help of the knob: from 0 (the softest rate) to 9 (the strongest rate). Press the key again: the braking rate is displayed in grey. With the help of the knob: from 1 (the softest rate) to 9 (the strongest rate) or 0 (no braking applied: deceleration is then under inertia).

The new value is automatically saved after 5 seconds or if the key for another parameter is pressed.

6.1.4. Temperature

A. Pre-cooling

Press the  key to start a pre-cool cycle: 2000 rpm, 15 minutes, +4 °C.

B. Programming Temperature

Press the  key until the display of the temperature goes to programming mode: only the temperature is displayed in grey. Select the required value with the help of the knob while in programming mode. The new value is automatically saved after 5 seconds or if the key for another parameter is pressed.

C. Instantaneous temperature reading

It is possible to read the instantaneous temperature in the lower part of the bowl, when the rotor is stopped.

Keep pressed the  key. The value is displayed in green.

6.2. Creating / Modification of a program

6.2.1. Creating a program

After switching on, the centrifuge displays the last program used.

Select the program number by pressing the  key, (short press). The program numbers will appear sequentially when turning the knob. Stop turning the knob once the required number is displayed. The word "prog" stops flashing after five seconds.

Enter the values for the different parameters as indicated above.

To memorize the program, hold the  key pressed in. The display becomes blue for a few seconds to confirm that the values have been saved.

6.2.2. Locking a program

The program created can be locked in order to protect it against accidental modification.

Press the Lid key  for 3 seconds. The display becomes red and displays "protected" to indicate that the program has been locked.

To unlock a program: recall the program. Press the Lid key  for 3 seconds. The display becomes blue and displays "unprotected" to indicate that the program has been unlocked.

6.2.3. Program selection

Recall the program by pressing the  key, (short press). The program numbers will appear sequentially when turning the knob.

Stop turning the knob once the required number is displayed. The word "prog" stops flashing after 5 seconds. The centrifuge is ready to start the selected program.

Note: The numbers of locked programs appear in red.

6.2.4. Modification of a program

Recall the program (§ 6.2.3). Modify the value(s) required. Press the  key for a long time. The display becomes blue for several seconds to confirm that the values have been saved.

6.3. Using a program

After having defined the parameters, fitted and correctly loaded the rotor, then closed the lid, press the  key to launch the selected program, or a routine configuration.

6.4. Display functions during rotation

Once the centrifugation cycle started, it is possible to check the current set points or change some of the displayed information to adapt to your need.

6.4.1. Cycle parameter check

Press the  key and keep pressing it. The display then shows the current cycle set points, till the key is released. Once the key released, the display switches back to the current values.

6.4.2. RPM / RCF indication

Pressing  (short press) makes the display toggling between the speed indication in "RPM" and the centrifugal force indication in "g".

6.4.3. °C / °F temperature indication

Pressing  (short press) makes the display toggling between the °C and °F temperature unit. Important note: if the current temperature is greater than 99 °F, and the °F display mode is selected, the temperature indication remains saturated to 99 °F. In other words, 99 °F means 99 °F or more.

6.5. Force slope n°9 during braking

When the programmed slope is lower than 9, it is possible to force the braking with slope 9 with this procedure:

Keep pressing on  key during more than 3s.

Only the current centrifugation cycle braking slope is affected, the initially programmed slope is still memorized, and is still applied for every standard braking (end of duration, or short press on  key).

7. EXTRA OPTIONS

All DOMELE centrifuges have these extra options, to access, press long for 3 seconds on  .

7.1. Language EN-FR

You have two choices of languages, English and French. You can select one, just by scrolling the knob and waiting 2 seconds  . You don't need to press anywhere to select it, you just need to hold on.

7.2. Count AT-GO

Count AT position: counting down will start at reached speed.
 Count GO position: counting down will start when starting the cycle.

See above example:

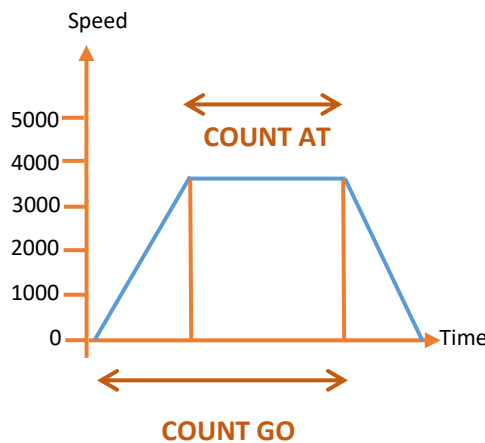

7.3. LBeep

The “Lid Beep” is an audible adviser while cover is closing. Select ON or OFF, according to your specific needs.

7.4. EBeep

Additionally to the SMART LIGHT visual signal of the end of the run, you can also add an audible adviser (beep) to advise the run has ended!
 Select ON or OFF.

7.5. Speed RCF/RPM

Both speed (RPM) and G force (RCF) can be displayed. If you need one to be displayed by default select it.

Factory setting is RCF (G force) by default.

7.6. Greasing advice

The DOMEL Centrifuges can remind you when to grease the accessories.



OFF	➔	NO REMINDER
-	➔	1 week
--	➔	1 month
---	➔	3 months
----	➔	6 months

Please then follow the maintenance recommendations for greasing.

7.7. Refrigeration

You can adjust the cooling system to maintain the requested temperature.

- OFF ➔ At the “End of the cycle” = the refrigeration stops.
- ON ➔ At the “End of the cycle” = Refrigeration until opening lid.

7.8. Pre-Diagnostic Mode

7.8.1. Cool ON

To verify that the refrigeration is working on, carry out a test of the cooling unit.

7.8.2. Power ON

To verify if the “power contactor” is working on, carry out a test of power contactor.

7.8.3. A loc

Carry out the test of cover lock system.

7.9. Diagnostic mode

7.9.1. Cod or 000

Access through passwords exclusively. Restricted to persons authorized by DOMEL Technicians trained on DOMEL Centrifuges.

8. CARE AND MAINTENANCE

8.1. Daily care and cleaning

8.1.1. External body

Wipe off marks from the paintwork of the external body and keyboard using an absorbent paper and lightly wetted with an alcohol-water solution or a quaternary ammonium compound.

8.1.2. Bowl and accessories

Keep the centrifugation bowl and accessories clean and dry.

NEVER USED CHLORINATED PRODUCTS (bleach, quaternary ammonium chloride...).

8.2. Weekly care and cleaning

Wash the rotors with clean or distilled water. Dry them carefully, particularly the parts that are not easy to access. When necessary, use a hairdryer to completely dry the small diameter pockets in the rotor. Do not forget to clean the central part of the rotor with a soft, non-metallic brush.

After cleaning, add a light film of silicone (using a spray), or lanolin to the surface of the rotor and in the pockets. This precaution will extend the life of metallic accessories.

Swing-out rotors: Check the greasing of the pins on which the buckets swing. Replace this regularly -- at least once per month -- in order to ensure that the buckets swing freely. Spread on a little grease by hand.

The "Please put grease" warning message is periodically displayed at the centrifuge power ON. The default period is 1 month for a normal use. The message period can be configured, the 4 possible settings are:

1 week, 1 month, 3 months and 6 months.



Failure to grease correctly could create an imbalance related to one or more buckets not swinging. Use food quality grease only.

8.3. Storage of accessories

Never leave a wet or moist rotor on a metallic surface, even stainless steel (risk of corrosion).

Unused rotors and accessories should be placed on a non-metallic grid with pockets/openings pointing downwards, in order that any liquid or condensate can drain out.

Take care to clean and dry rotors that will be stored for weeks or months before use. Cover them with a fine layer of silicone grease, using a spray.

Equally, rotors stored in a cold room must be protected against humidity by a layer of silicone grease.

8.4. Action to be taken in the case of broken glass or accidental spillage

Before any intervention, switch off and unplug the centrifuge. The user is responsible for the decontamination, in case of spilling contaminated liquid in the centrifuge.

8.4.1. Material presenting no toxic, biological or radioactive risk

Wear protective gloves to avoid any risk of injury and a mask in case of airborne contaminants.

Dismount the rotor. Remove all debris and mop up spillages using compresses or absorbent paper.

Deal with all waste using the correct means for material that can stab, cut or slice.

8.4.2. Material presenting a biological risk

Transport the sealed accessory (rotor, bucket together with its sealed lid) to the inside of a microbiological safety cabinet. Open it and dispose of the contents into an autoclave bag. Clean and rinse the accessory in the safety cabinet and place it in the second autoclave bag. Autoclave the two bags for 15 minutes at 122.5°C/252.5°F, or according to the appropriate protocol for the material to centrifuge. Deal with the bag containing the broken tubes according to the method for treating cutting, slicing contaminated waste. Remove the cleaning residues from the accessory according to the protocol for eliminating biological waste from the laboratory.

8.4.3. Material presenting a radioactive risk

Comply with the decontamination protocol in use in the laboratory.

8.4.4. Material presenting a toxic risk

Comply with the decontamination protocol in use in the laboratory.

8.5. Sterilization and disinfection of the rotor bowl and its accessories

Comply with the decontamination protocol in use in the laboratory.

The following solutions are recommended:

- **70% Ethanol in water solution**
- **Non-halogenated quaternary ammonium solutions**

For autoclavable accessories: autoclave at 121°C/252°F for 15 minutes.

When autoclaved, lids, seals, buckets and rotors should be separated from each other.

The use of other products is subject to the prior agreement of DOMEL.

Before using any cleaning or decontaminating methods except those recommended here above, users should check with DOMEL that the proposed method will not damage the equipment.

8.6. Checks and tests on accessories

These checks help in providing operator safety.

All accessories:

Carry out regularly - at least once per month - a visual inspection of rotors and accessories.

Check for traces of corrosion, wear and surface faults (scratches, cracks).

Replace the accessory if there is a significant fault.

Sealed accessories:

Check the airtight seals and replace them after they have been autoclaved 10 times.

Check the sealing lids. Replace them if the colour has changed, they have become opaque or if there are significant scratches.

8.7. Yearly maintenance

It is recommended to have a functional check (Greasing of the motor shaft, of the locking device, readability of the stickers), a security check (Continuity of the grounding (earthing), locking), and a performance check of the centrifuge at least once a year.

Check that the ground (earth) continuity of the machine is still properly ensured by the power cord and the wall outlet to which it is connected.

No access to the inside the centrifuge is authorized. Maintenance is carried out by a DOMEL certificated technician.

9. TROUBLESHOOTING / MESSAGES

Displayed	Fault	Cause	Centrifuge Response	Action
"Err 001"	Imbalance	Poor loading of rotating accessories (unbalanced)	Braking to a complete stop	Reload the rotating accessory and restart the centrifugation. An imbalance higher than or equal to 15 g is forbidden.
"Lid OPEn"	Lid open	The lid has been unlocked manually during rotation (abnormal and dangerous handling)	Power to the motor is cut immediately and the rotor turns freely until it stops	Wait until the complete stop. Switch off the centrifuge for several seconds then switch it on again, press the lock/unlock key to open the lid, close the lid again and restart the centrifugation. If the problem persists, contact the DOMEL service department.
		The "locked position" detectors are defective or badly adjusted		
"Err 003" (Refrigerated centrifuge)	Bowl temperature too high	The set temperature is too high	Braking to a complete stop	Check the conditions of use (set temperature below 40°C and ambient temperature below or equal to 25°C). Once the correct conditions of use have been checked and/or re-established, restart the centrifugation. If the problem persists, contact the DOMEL service department.
		The ambient temperature is too high		
		The cooling system is faulty		
		The temperature detector is faulty or badly connected		
"Err 004"	Motor temperature too high	The ambient temperature is too high	Braking to a complete stop	Check the ambient temperature: it must be below or equal to 25°C. Let the centrifuge cool for 1h. Once the correct conditions of use have been checked and/or re-established, restart the centrifugation. If the problem persists, contact the DOMEL service department.
		The motor temperature detector is faulty or badly connected		
		The motor is damaged		
"Err 005" / count down	No speed signal	Rotating accessory jammed in the bowl	Wait for the 120s countdown to finish before pressing the stop and escape button to clear the fault. The lid cannot be opened until the fault is cleared. Identify the reason for fault error before proceeding.	Check that the loading of the rotating accessory does not exceed its specifications and that no obstacle to rotation has become accidentally lodged in the bowl. Restart the centrifugation once these checks have been carried out. If the problem persists, contact the DOMEL service department. Important: Do not attempt to refit by yourself a magnet that has become detached from the rotating accessory: a special type of glue must be used and the operation carried out by an engineer trained by DOMEL.
		Excessive loading		
		Rotating accessory incompatible with the centrifuge		
		Defective power board / cabling / or motor		
		Missing magnet on a rotating accessory		
"Err 006" / count down	Irregular speed signal	Rotating accessory incompatible with the centrifuge	Rotor turns freely until it stops; impossible to open the lid before the end of the count down (1200s, 20min)	Check on the state and the type of a rotating accessory. Check that the accessory is correctly loaded (balanced). Restart the centrifugation once these checks have been carried out. If the problem persists, contact the DOMEL service department. Important: Do not attempt to refit by yourself a magnet that has become detached from the rotating accessory: a special type of glue must be used and the operation carried out by an engineer trained by DOMEL.
		Missing magnet		
		Major imbalance of the rotating assembly		

"Err 007"	Not used	Not used	Not used	Not used
"Err 008"	Lid Switch error	The 2 Lid switches are seen "closed" at the same time	Impossible to start the centrifuge till the problem is solved	Try to open or close the Lid again, check that nothing is inserted in the right locking system hole. Switch the unit OFF wait a few seconds and switch it ON again. If the problem persists, contact DOMEL service department.
"Err 009"	Imbalance error	The centrifuge is not properly installed, (the bench is not horizontal)	Impossible to start the centrifuge till the problem is solved	Wait 1min, and try to start the centrifuge again, if Err 09 is still displayed, check that the centrifuge is properly installed (level), If levelling is not correct, turn the unit OFF, adjust its level, turn the unit ON and wait 1min before starting the centrifuge again. If Err 09 is still there, check that no other appliances induce vibrations on the table. If not, contact DOMEL service department.
		the centrifuge has been shocked / moved while powered		
		the previous run stops because of a high imbalance		
"Err 010"	Lid board Error	It is not possible to communicate with the Lid board	Braking to a complete stop	Wait for full stop if centrifuge was rotating. Turn it OFF, wait a few seconds, turn it ON. Try to start the cycle. If the problem persists, contact DOMEL service department.

Information / warning messages:

Displayed		Cause	Action
« Please put Grease »	Colour: Grey	This message appears periodically during centrifuge power ON phase, to remember that the swing out rotors pins have to be correctly greased to avoid vibrations and achieve the best separation results. The display period of this message can be adjusted from 1 week to 1, 3 or 6 months.	Reset the message by pressing  key when the Stop LED is ON. Refer to chapter 7 to grease the swing out rotor pins if needed. Reset and ignore this message if only angular rotors are used on the centrifuge.
« Service »	Colour: red Service key LED blinking	The centrifuge reached 30000 centrifugation cycles, the accessories need to be checked by a DOMEL certified Service. The display remains red till the needed service operation is done.	Call DOMEL service department in order to have the accessories checked, and the warning message reset.
« Press Lid button »	Colour: Green	The locking system needs to be reset	Press the open key to reset the locking system. Once done, the message disappears and the centrifuge is ready for a normal use.

10. DISPOSAL

Information concerning the disposal of electrical and electronic equipment in the European Union.

Electrical equipment is governed by national rules based on European Directive 2002/96/CE relating to electrical and electronic equipment waste (EEEW).

To conform to this directive, all equipment delivered after 13 August 2005 in the business-to-the business sector -- to which this centrifuge belongs (category 8, Medical Devices) -- must not be disposed of with domestic waste.

To facilitate their identification, the equipment concerned is provided with the following symbol:

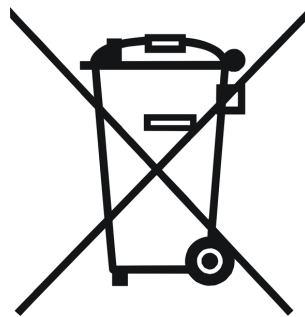

The regulations related to the disposal of such waste vary from one country to another within the EU and we invite you to contact your local supplier.

11. CERTIFICATE OF DECONTAMINATION / RETURNS FORM

Equipment will not be accepted without the returns form and the certificate of decontamination which must be fixed to the outside of the packaging. In the absence of a certificate of decontamination the instrument will be decontaminated by an external organization and the operation will be invoiced to the sender.

CERTIFICATE OF DECONTAMINATION

I, the undersigned,

First name:
Surname:
Title:
Company:
Address:
Post Code:
City:

Certify that the equipment described below:

Brand:
Model:
Serial Number:

Has been decontaminated according to the following protocol:

Decontaminating agent:
Method:
Contact time:
Carried out by:
Checked by:
Date:

Date:

Signature:

RETURN FORM

Date:

Company:

Contact:

Address:

.....

.....

Telephone:

Fax:

E-mail:

Equipment returned:

Brand:

Model:

Serial N°:

Under warranty: YES NO

Contract N°:

Reason for returning:

.....

.....

.....

.....

13. NOMOGRAM

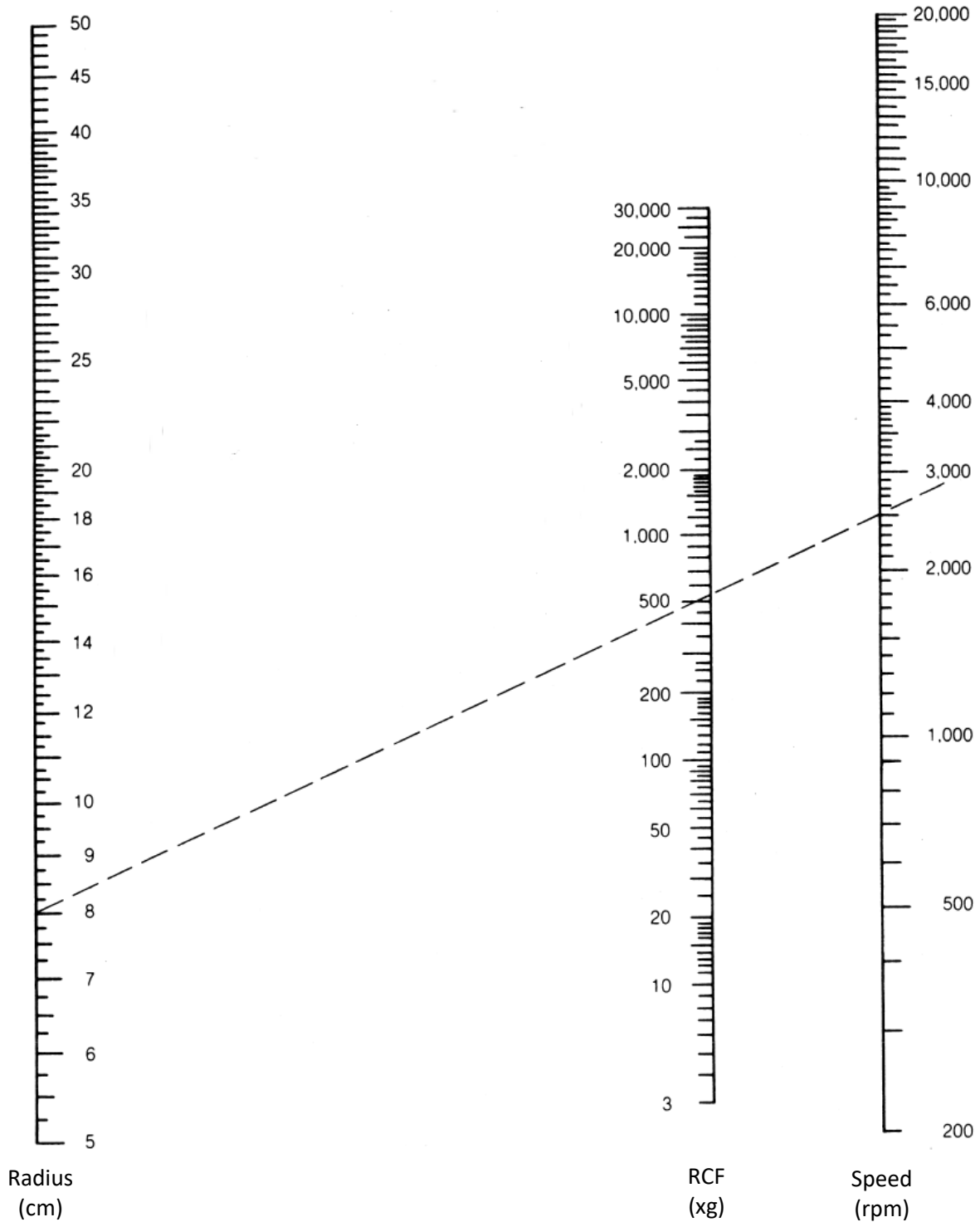

Example:
 The relative centrifugal force (RCF) at a radial distance of 8cm from the center of centrifuge spindle when operating at a speed of 2500 rpm, may be determined by placing a straight edge on the nomogram connecting the 8cm point on the Radius Scale (on the left), with the 2500 rpm point on the Speed Scale (on the right). The point of intersection on the Relative Centrifugal Force Scale (in the middle), or 550g is the relative centrifugal force.

14. QUICK START

Choose the program

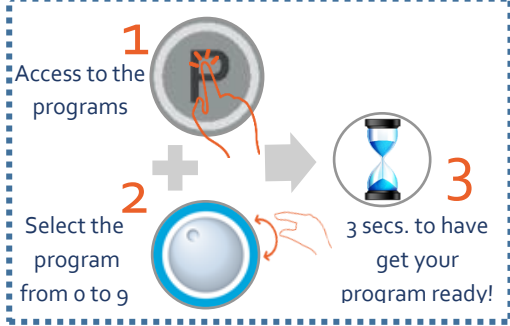

1. Set Program

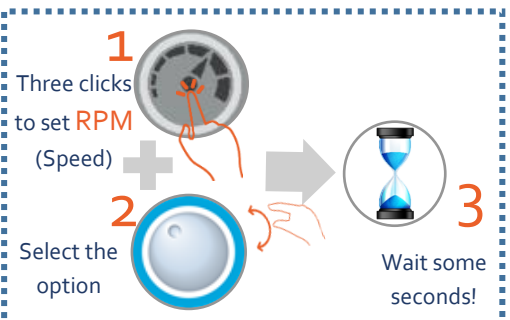
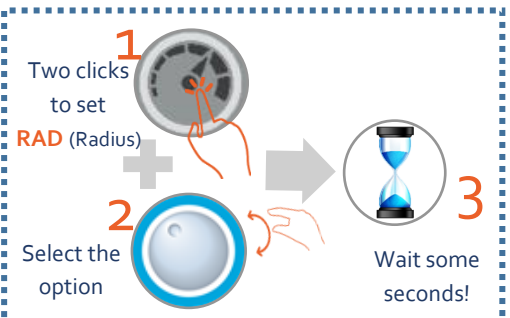
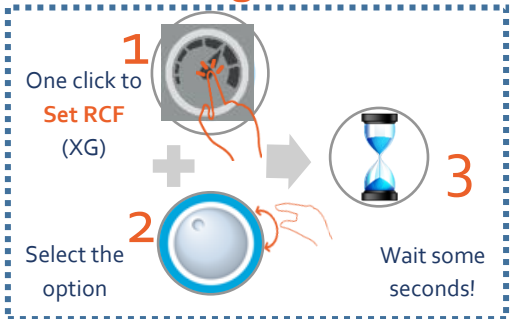

2. Set time



3. Set Temperature

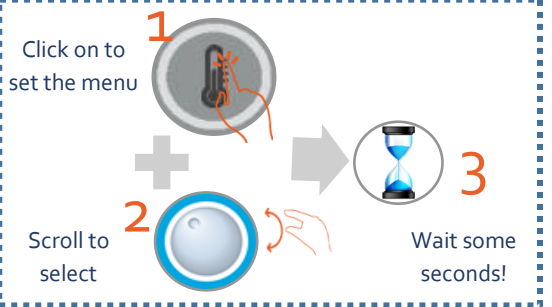

4. Set Slopes

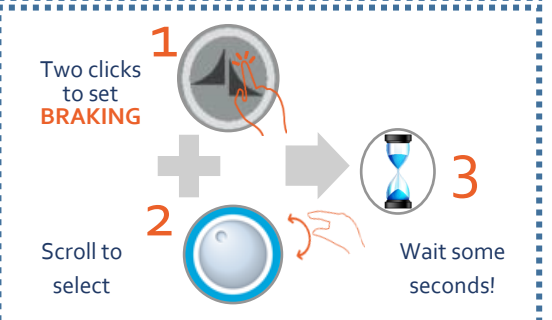
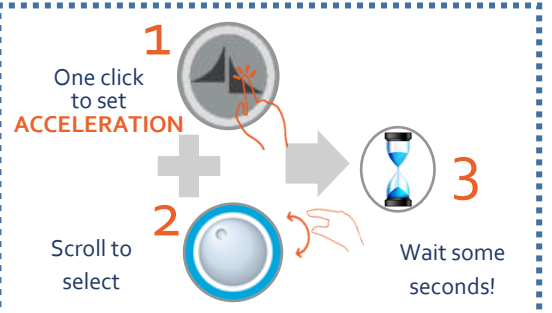

Create & save a program



Lock a program



Unlock a program



Start Centrifugation



Pre Cool Program

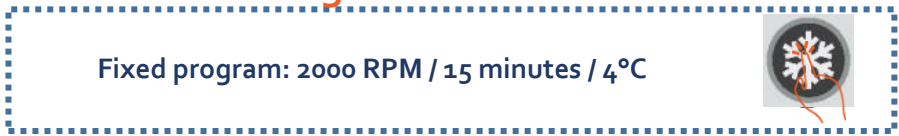



EU DECLARATION OF CONFORMITY

Manufacturer / name and address

Domel, d.o.o.
BU Laboratory Systems
Otoki 21
4228 Železniki
Slovenia

DOMEL®

We declare under our sole responsibility that

product:
type / model:

Laboratory centrifuge
Centric CF 48, Centric CF 48 R

is in conformity with the provisions of the following regulations and also complies with the following standards

1. Directive 2014/35/EU of the European Parliament and of the Council of 26 February 2014 on the harmonisation of the laws of the Member States relating to the making available on the market of electrical equipment designed for use within certain voltage limits

Standards: EN 61010-1:2010, EN 61010-2-020:2017

2. Directive 2014/30/EU of the European Parliament and of the Council of 26 February 2014 on the harmonisation of the laws of the Member States relating to electromagnetic compatibility

Standards: EN 61326-1:2013

3. Directive 2011/65/EU of the European Parliament and of the Council of 8 June 2011 on the restriction of the use of certain hazardous substances in electrical and electronic equipment, amended by Commission Delegated Directive (EU) 2015/863 and Directive (EU) 2017/2102 of the European Parliament and of the Council

Standards: EN IEC 63000:2018

Place and date of issue

Name, surname and signature of authorized person

Železniki, 09.06.2023

manager

Andrej Eržen